

User manual

Tumble dryer

TD6–6 Lagoon
Type N1130..



Electrolux
PROFESSIONAL

Contents

Contents

| | | |
|-----|--|----|
| 1 | Safety Precautions | 5 |
| 1.1 | General safety information..... | 6 |
| 1.2 | Commercial use only..... | 6 |
| 1.3 | Ergonomics certification | 6 |
| 1.4 | Symbols..... | 7 |
| 2 | Warranty terms and exclusions..... | 8 |
| 3 | Program description | 9 |
| 3.1 | Lagoon programs..... | 9 |
| 3.2 | General programs..... | 10 |
| 4 | Handling..... | 11 |
| 4.1 | Load | 11 |
| 4.2 | To start the machine..... | 13 |
| 4.3 | Additional functions..... | 13 |
| 4.4 | When program has ended | 14 |
| 5 | Error codes | 15 |
| 6 | Maintenance | 15 |
| 6.1 | General..... | 15 |
| 6.2 | Time for maintenance..... | 15 |
| 6.3 | Every day..... | 15 |
| 6.4 | Fresh air intake..... | 16 |
| 6.5 | Machines with residual moisture control (RMC)..... | 16 |
| 6.6 | Maintenance to be carried out by qualified service personnel | 16 |
| 7 | Disposal information | 17 |
| 7.1 | Disposal of appliance at end of life | 17 |
| 7.2 | Disposal of packing..... | 17 |

The manufacturer reserves the right to make changes to design and component specifications.

1 Safety Precautions

- Servicing shall be carried out only by authorized personnel.
- Only authorized spare parts, accessories and consumables shall be used.
- The machine is not to be used if industrial chemicals have been used for cleaning.
- Do not dry unwashed items in the machine.
- Items that have been soiled with substances such as cooking oil, acetone, alcohol, petrol, kerosene, spot removers, turpentine, waxes and wax removers should be washed in hot water with an extra amount of detergent before being dried in the machine.
- Items such as foam rubber (latex foam), shower caps, waterproof textiles, rubber backed articles and clothes or pillows fitted with foam rubber pads should not be dried in the machine.
- Fabric softeners or similar products should be used as specified by the fabric softener instructions.
- The final part of a drying cycle occurs without heat (cool down cycle) to ensure that the items are left at a temperature that ensures that the items will not be damaged.
- Remove all objects from pockets such as lighters and matches.
- **WARNING.** Never stop the machine before the end of the drying cycle unless all items are quickly removed and spread out so that the heat is dissipated.
- Adequate ventilation has to be provided to avoid the back flow of gases into the room for appliances burning other fuels, including open fires.
- Exhaust air must not be discharged into a flue which is used for exhausting fumes from appliances burning gas or other fuels.
- The machine must not be installed behind a lockable door, a sliding door or a door with a hinge on the opposite side to that of the machine in such a way that a full opening of the machine is restricted.
- If the machine has a lint trap this has to be cleaned frequently.
- The lint must not be accumulated around the machine.
- **DO NOT MODIFY THIS APPLIANCE.**
- When performing service or replacing parts, the power must be disconnected.
- When the power is disconnected, the operator must see that the machine is disconnected (that the plug is removed and remains removed) from any point to which he has access. If this is not possible, due to the construction or installation of the machine, a disconnection with a locking system in the isolated position shall be provided.
- In accordance with the wiring rules: mount a multi-pole switch prior to the machine to facilitate installation and service operations.
- **WARNING:** The appliance must not be supplied through an external switching device, such as a timer, or connected to a circuit that is regularly switched on and off by a utility.
- If different rated voltages or different rated frequencies (separated by a /) are stated at the machine data plate, instructions for adjusting the appliance for operation at the required rated voltage or rated frequency are stated in the installation manual.
- Stationary appliances not fitted with means for disconnection from the supply mains having a contact separation in all poles that provide full disconnection under overvoltage category III, the instructions state that means for disconnection must be incorporated in the fixed wiring in accordance with the wiring rules.
- The openings in the base, shall not be obstructed by a carpet.

- Oil-affected items can ignite spontaneously, especially when exposed to heat sources such as in a tumble dryer. The items become warm, causing an oxidation reaction in the oil. Oxidation creates heat. If the heat cannot escape, the items can become hot enough to catch fire. Piling, stacking or storing oil-affected items can prevent heat from escaping and so create a fire hazard.
- If it is unavoidable that fabrics that contain vegetable or cooking oil or have been contaminated by hair care products be placed in a tumble dryer they should first be washed in hot water with extra detergent – this will reduce, but not eliminate, the hazard.
- Maximum mass of dry cloth: 6 kg.
- A-weighted emission sound pressure level at working stations: 70 dB(A).
- Additional requirements for the following countries; AT, BE, BG, HR, CY, CZ, DK, EE, FI, FR, DE, GR, HU, IS, IE, IT, LV, LT, LU, MT, NL, NO, PL, PT, RO, SK, SI, ES, SE, CH, TR, UK:
 - The appliance can be used in public areas.
 - This appliance can be used by children aged from 8 years and above and persons with reduced physical, sensory or mental capabilities or lack of experience and knowledge if they have been given supervision or instruction concerning use of the appliance in a safe way and understand the hazards involved. Children shall not play with the appliance. Cleaning and user maintenance shall not be made by children without supervision.
- Additional requirements for other countries:
 - This appliance is not intended for use by persons (including children) with reduced physical, sensory or mental capabilities, or lack of experience and knowledge, unless they have been given supervision or instruction concerning use of the appliance by a person responsible for their safety. Children should be supervised to ensure that they do not play with the appliance.

1.1 General safety information

In order to prevent damage to the electronics (and other parts) that may occur as the result of condensation, the machine should be placed in room temperature for 24 hours before being used for the first time.

1.2 Commercial use only

The machine/machines covered by this manual is/are made for commercial and industrial use only.

1.3 Ergonomics certification

The human body is designed for movement and activity but physical stress injuries as a result of static and repetitive movements or unfavorable working postures may occur.

The ergonomic features of your product, the ones which may influence your physical and cognitive interaction with it, have been assessed and certified.

A product which exhibits ergonomic features, in fact, shall fulfil specific ergonomic requirements, belonging to three different areas: Polytechnic, Biomedical and Psychosocial (usability and satisfaction).

For each of these areas, specific tests with real users have been performed. The product was therefore compliant with the ergonomic acceptability criteria requested by the standards.





In case several machines are managed by the same operator the repetitive movements will increase and as a consequence of this the related biomechanical risk will increase exponentially.

The possible postural risks are the interaction with the door handle in case the machine is placed directly on the floor without a base and with the door handle and the user interface, display and knob, in case the machine is placed on top of a washing machine.

Follow the below recommendations to avoid, as much as possible, operators acquiring bodily injury.

- Place the machine on a base instead of directly on the floor so that the operator does not need to bend his/her back unnecessarily when loading and unloading.
Minimum suggested height of bases is 300 mm.
- Make sure there are suitable trolleys or baskets for loading, unloading and transportation.
- Organize job rotation in the working place in the case several machines are managed by the same operator.

1.4 Symbols

| | |
|---|--|
|  | Caution |
|  | Caution, hot surface |
|  | Caution, high voltage |
|  | Read the instructions before using the machine |

2 Warranty terms and exclusions

If the purchase of this product includes warranty coverage, warranty is provided in line with local regulations and subject to the product being installed and used for the purposes as designed, and as described within the appropriate equipment documentation.

Warranty will be applicable where the customer has used only genuine spare parts and has performed maintenance in accordance with Electrolux Professional user and maintenance documentation made available in paper or electronic format.

Electrolux Professional strongly recommends using Electrolux Professional approved cleaning, rinse and descaling agents to obtain optimal results and maintain product efficiency over time.

The Electrolux Professional warranty does not cover:

- service trips cost to deliver and pick up the product;
- installation;
- training on how to use/operate;
- replacement (and/or supply) of wear and tear parts unless resulting from defects in materials or workmanship reported within one (1) week from the failure;
- correction of external wiring;
- correction of unauthorized repairs as well as any damages, failures and inefficiencies caused by and/or resulting from:
 - insufficient and/or abnormal capacity of the electrical systems (current/voltage/frequency, including spikes and/or outages);
 - inadequate or interrupted water supply, steam, air, gas (including impurities and/or other that does not comply with the technical requirements for each appliance);
 - plumbing parts, components or consumable cleaning products that are not approved by the manufacturer;
 - customer's negligence, misuse, abuse and/or non-compliance with the use and care instructions detailed within the appropriate equipment documentation;
 - improper or poor: installation, repair, maintenance (including tampering, modifications and repairs carried out by third parties not authorized third parties) and modification of safety systems;
 - Use of non-original components (e.g.: consumables, wear and tear, or spare parts);
 - environment conditions provoking thermal (e.g. overheating/freezing) or chemical (e.g. corrosion/oxidation) stress;
 - foreign objects placed in- or connected to- the product;
 - accidents or force majeure;
 - transportation and handling, including scratches, dents, chips, and/or other damage to the finish of the product, unless such damage results from defects in materials or workmanship and is reported within one (1) week of delivery unless otherwise agreed;
- product with original serial numbers that have been removed, altered or cannot be readily determined;
- replacement of light bulbs, filters or any consumable parts;
- any accessories and software not approved or specified by Electrolux Professional.

Warranty does not include scheduled maintenance activities (including the parts required for it) or the supply of cleaning agents unless specifically covered within any local agreement, subject to local terms and conditions.

Check on Electrolux Professional website the list of authorized customer care.

3 Program description







There are two types of programs, automatic programs and time programs.



Automatic programs has moisture detection and will stop when selected dryness is achieved.

Time programs has no moisture detection and will stop when the preset or selected time has ended.

3.1 Lagoon programs











The following table shows some examples of available programs and a short description of those:

| Automatic programs | Description |
|--|---|
| WOOL HIGH  | Wool coat, jumper, heavy suit jacket, trousers. The program will stop when set dryness is achieved. |
| WOOL MEDIUM  | Wool suit jacket, wool skirt. The program will stop when set dryness is achieved. |
| SILK  | Silk dress, viscose dress. The program will stop when set dryness is achieved. |
| AIO MILD  | Cotton suit, linen suit, rain coat. Mixed fibre with cotton The program will stop when set dryness is achieved. |
| AIO GENTLE  | Synthetic fur. Mixed fibre with viscose. Mixed fibre with polyester. The program will stop when set dryness is achieved. |
| CURTAINS  | Curtains, ties in the net. The program will stop when set dryness is achieved. |

| Time programs | Description |
|---|--|
| HIGH  | Cotton and terry. Different drying times can be selected. The program will stop when the time is up. |
| LOW  | Synthetic (example of synthetic fabrics: polyester, polyamide, polyacrylic and elasthan), viscose, polycotton and delicate fabrics. Different drying times can be selected. The program will stop when the time is up. |
| NO HEATING  | Airing bedspreads, duvets and bedclothes. Different drying times can be selected. The program will stop when the time is up. |

3.2 General programs

The following table shows some examples of available programs and a short description of those:

| Automatic programs | Description |
|--|--|
| COTTON EXTRA DRY  | Denim and terry. The program will stop when set dryness is achieved. |
| COTTON CARE  | Cotton and terry. The program will stop when set dryness is achieved. |
| COTTON IRON DRY  | Cotton. The program will stop when set dryness is achieved. |
| POLY COTTON DRY  | Viscose and polycotton. The program will stop when set dryness is achieved. |
| SYNTHETICS DRY  | Synthetic (example of synthetic fabrics: polyester, polyamide, polyacrylic and elasthan), viscose, polycotton and delicate fabrics. The program will stop when set dryness is achieved. |
| SYNTHETICS IRON DRY  | Synthetic (example of synthetic fabrics: polyester, polyamide, polyacrylic and elasthan), viscose, polycotton and delicate fabrics. The program will stop when set dryness is achieved. |
| Hidden programs | Description |
| COTTON  | Denim. The program will stop when set dryness is achieved. |
| COTTON  | Terry. The program will stop when set dryness is achieved. |
| COTTON  | Sheets. The program will stop when set dryness is achieved. |
| MICROFIBRE  | Microfibre. The program will stop when set dryness is achieved. |

4 Handling

4.1 Load

Note!

Remove all objects from pockets and make sure there are no metal objects such as screws, pins etc. left. Metal objects might cause damage to the drum.

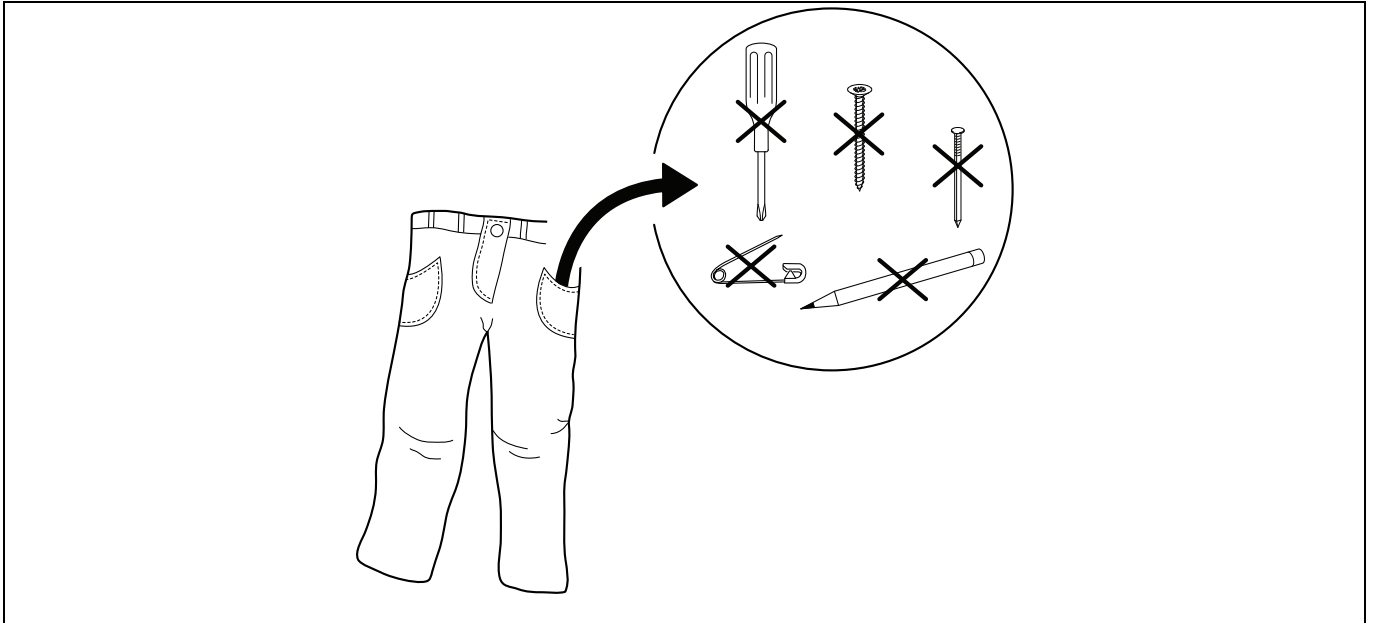

Make sure the filter is clean.

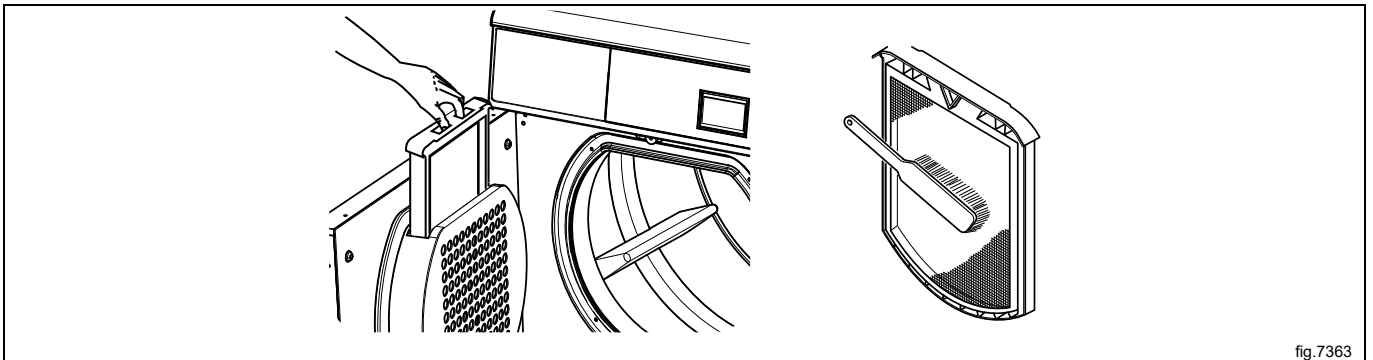
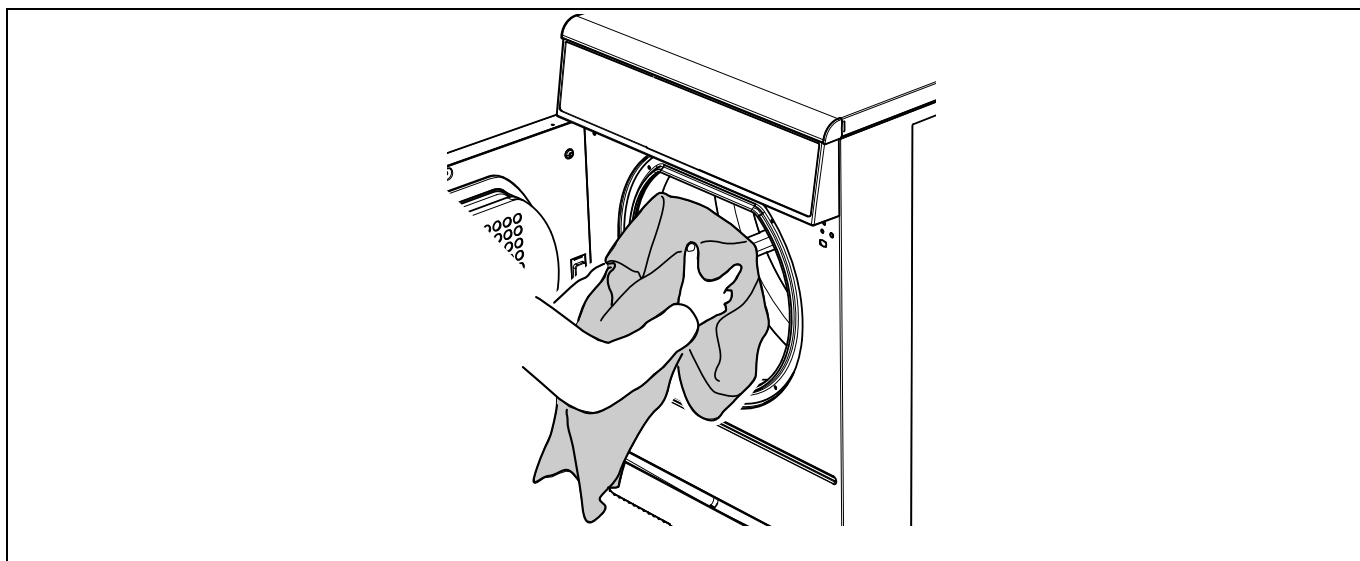

fig.7363

Load the goods into the machine and close the door.
The recommended maximum load is 6 kg.



4.2 To start the machine

Automatic programs

Select program with the control knob.

Start the machine by pressing the control knob.

Time programs

Select program with the control knob.

Start the machine by pressing the control knob.

After start it is possible to change the time for the selected program. Turn the control knob to set the desired time.

Coin operated machines

Select program with the control knob.

Insert correct amount of coins to start the machine and/or press the control knob.

After start it is possible to add time for the selected program. Insert more coins to add time.

4.3 Additional functions

There is a menu with additional functions available for selection after start. When pressing the control knob the menu will appear on the display.

Select from the menu by turning the control knob and press the control knob to activate.

Note!

Some of the functions may not be available or active on your machine.

Pause

It is possible to pause an ongoing program.

Select PAUSE and activate.

For some machines it is also possible to pause directly when pressing the control knob.

When pressing the control knob again the program will continue.

End a program

It is possible to end a program after start.

Select END PROGRAM and activate.

When pressing the control knob the program will be ended.

Status

Select STATUS MENU and activate.

The status menu shows the status for inlet air temp, outlet air temp, RMC and if the heat is on or off in the machine.

4.4 When program has ended

Note!

For the best possible drying result it is important to empty the machine as soon as the program has ended.

If the machine is not emptied as soon as the program has ended the drum will rotate in short intervals in order to keep the goods from being wrinkled.

Clean the filter after each drying cycle for best performance.

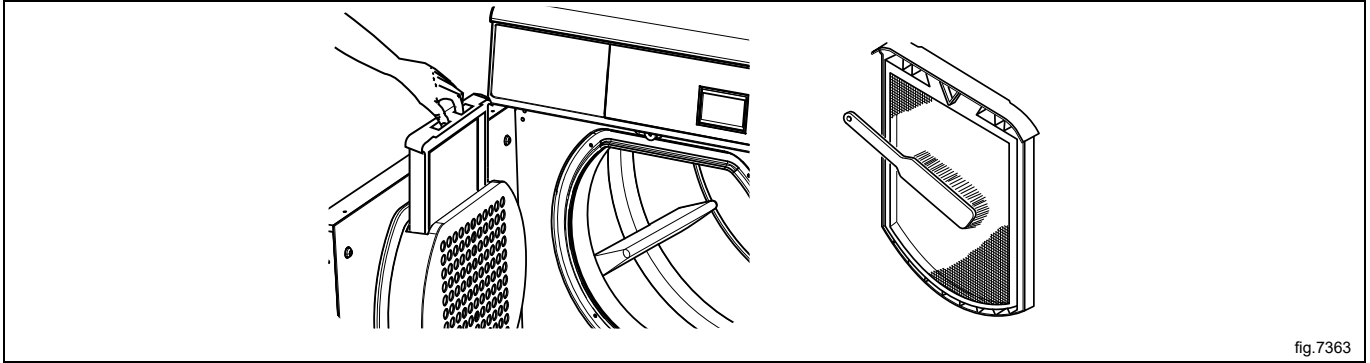

fig.7363

5 Error codes

A fault in the program or in the machine is indicated by an error code on the display. Some of these error codes can be solved easily without contacting service personnel.

| Error code | Text | Cause/Action |
|------------|------------------------------------|--|
| 12:11 | DRYING ERROR WITH RMC PROGRAM | The longest permitted RMC time has been exceeded. (Applies only to machines with RMC). The machine is overfilled or the garment is too wet. |
| 12:12 | DRYING ERROR WITH AUTOSTOP PROGRAM | The longest permitted automatic stop time has been exceeded. (Applies only to machines with automatic stop). The machine is overfilled or the garment is too wet. |
| 12:18 | REDISTRIBUTION OF LOAD NEEDED | Machine indicates that load is blocking the airflow. Redistribute the load. Restart the machine to clear error message. |
| 20:1 | O.H. DRUM MOTOR | The motor is too hot. The machine will restart automatically when the temperature on the motor is OK (if the door has not been opened). |

6 Maintenance

6.1 General

It is the responsibility of the owner of the machine/the laundry manager to make sure that maintenance is periodically performed.

Note!

Lack of maintenance may deteriorate the performance of the machine and may cause damage to components.

6.2 Time for maintenance

When the display is showing the message `TIME FOR MAINTENANCE` — contact the owner of the machine/the laundry manager to perform maintenance (if available, a telephone number and/or a tag will also be displayed).

The machine can be used meanwhile. However, the message will keep coming back until the service is performed.

The message will disappear after about 30 seconds or if the control knob or any button is pressed.

6.3 Every day

Check that the machine does not operate with the door or filter door open, if so, the machine must be placed out of order until repairs are made.

Note!

Contact qualified service personnel to disconnect power from the affected machine.

Clean the door, door gasket and other external parts.

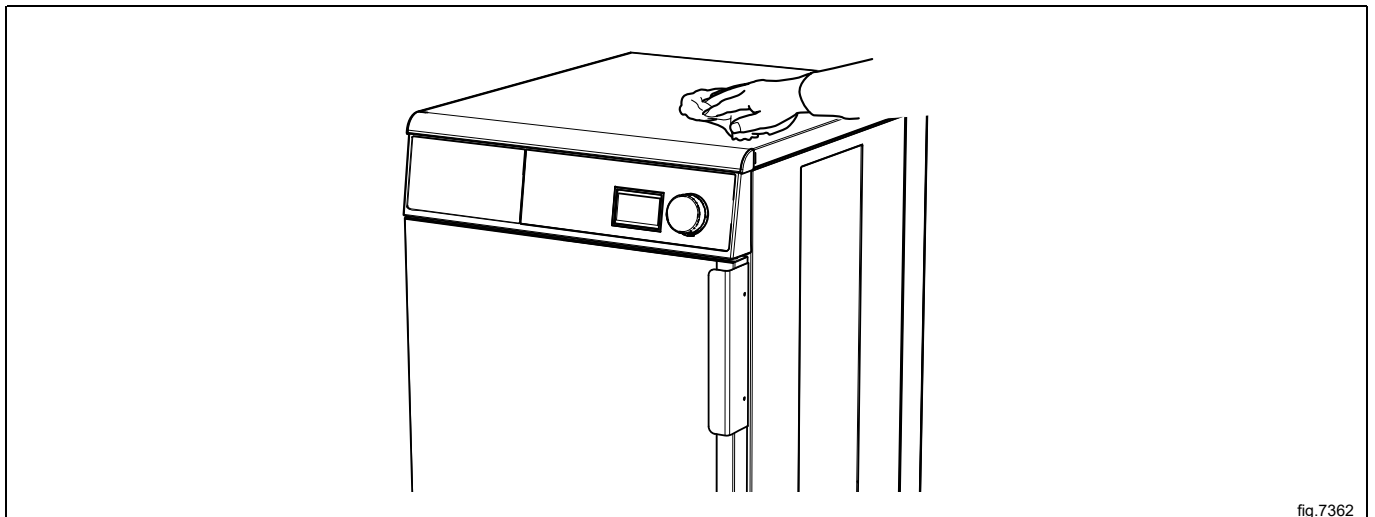
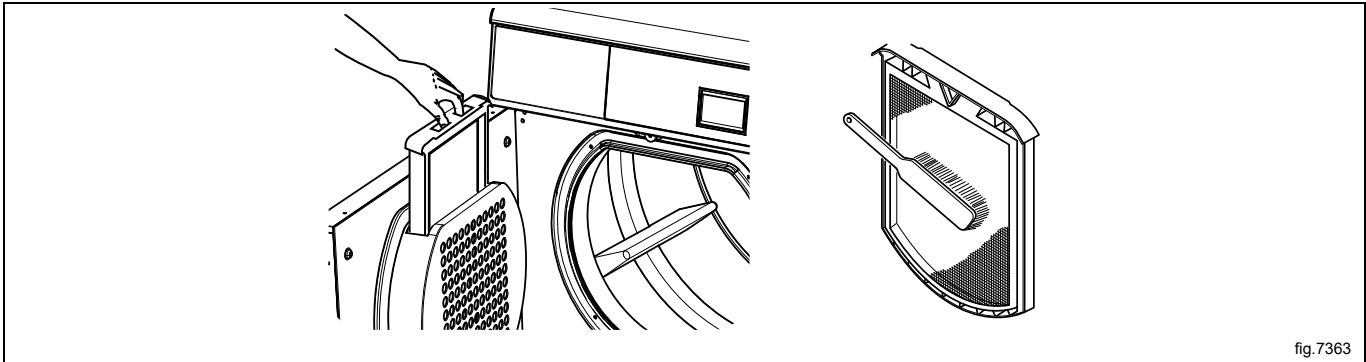

fig.7362

Check that the filter is clean and unbroken. Clean or replace if necessary.



Remove any lint and dust around the machine.



6.4 Fresh air intake

At regular basis, check that the fresh air intake on the front of the machine is not clogged by lint and dust or otherwise blocked.

Clean with a vacuum cleaner.

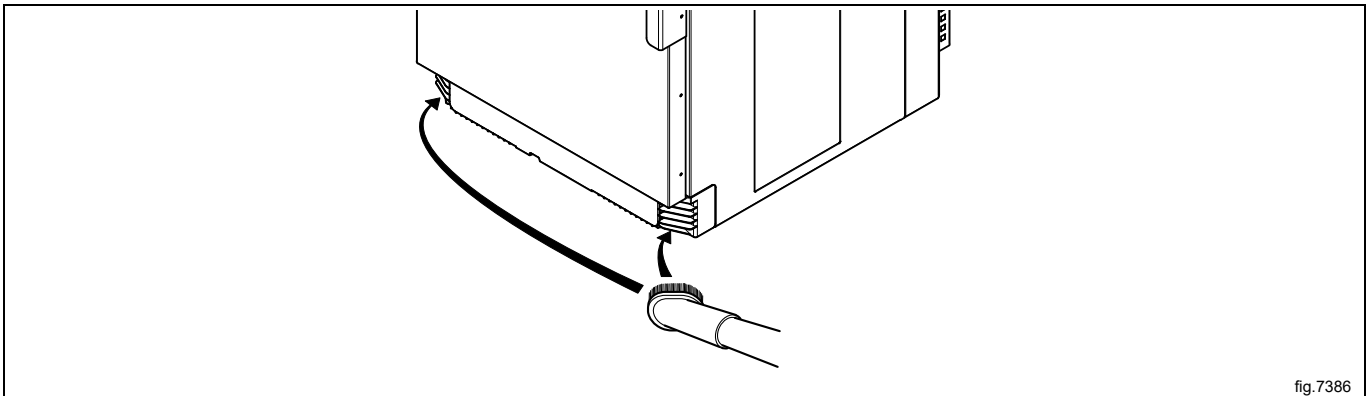

6.5 Machines with residual moisture control (RMC)

At regular basis, wipe off/clean drum and lifters with citric acid (*Acidum citricum*). If soap/softener residue remains, it is recommended also to use a coarse sponge.

Lack of cleaning can affect the functionality of the residual moisture control. This can result in more moist load than requested at program end.

6.6 Maintenance to be carried out by qualified service personnel

Contact qualified service personnel to perform the following maintenance:

After 1600 hours of operation or once a year, whichever comes first:

- Clean the fan, the exhaust duct and the fresh-air intake to the room
- On machines with RMC: Clean the glide surface on the RMC graphite collector
- Clean the area around the drum
- Clean the motors
- Check the belt tension

7 Disposal information

7.1 Disposal of appliance at end of life

Before disposing of the machine, make sure to carefully check its physical condition, and in particular any parts of the structure that can give or break during scrapping.

The machine's parts must be disposed of in a differentiated way, according to their different characteristics (e.g. metals, oils, greases, plastic, rubber, etc.).

Different regulations are in force in the various countries, therefore comply with the provisions of the laws and competent bodies in the country where scrapping takes place.

In general, the appliance must be taken to a specialised collection/scrapping centre.

Dismantle the appliance, grouping the components according to their chemical characteristics, remembering that the compressor contains lubricant oil and refrigerant fluid which can be recycled, and that the refrigerator and heat pump components are special waste assimilable with urban waste.



The symbol on the product indicates that this product should not be treated as domestic waste, but must be correctly disposed of in order to prevent any negative consequences for the environment and human health. For further information on the recycling of this product, contact the local dealer or agent, the Customer Care service or the local body responsible for waste disposal.



Note!

When scrapping the machine, any marking, this manual and other documents concerning the appliance must be destroyed.

7.2 Disposal of packing

The packing must be disposed of in compliance with the current regulations in the country where the appliance is used. All the packing materials are environmentally friendly.

They can be safely kept, recycled or burned in an appropriate waste incineration plant. Recyclable plastic parts are marked as following examples.

| | |
|---|--|
|  | Polyethylene: <ul style="list-style-type: none"> • Outer wrapping • Instructions bag |
|  | Polypropylene: <ul style="list-style-type: none"> • Straps |
|  | Polystyrene foam: <ul style="list-style-type: none"> • Corner protectors |



Electrolux Professional AB
341 80 Ljungby, Sweden
www.electroluxprofessional.com